

Client _____ Quantity _____
 Project _____ Position _____

Prep-station GN1/1 counter 4 doors

Model: TV21/1M-1/6-710 **Cod:** T10401000231



Technical data

Top:	With top
Gross capacity:	599 lt
Temperature range:	-2°+8°C
Refrigerant unit:	Plug-In
Cooling gas:	R290
Defrost:	Hot gas
Body height:	710 mm
Valve:	Supplied standard with solenoid
Dimensions:	2260×700×1005 mm
Packing dimensions:	2355×800×1050 mm
Gross weight:	220 Kg
Voltage:	220-240 V - 50 Hz
Total rate:	250 W
Absorbed Current:	1,15 A
Cooling capacity:	406 W*
*:	Evap. -10°C Cond. +55°C

Features

Standard equipment:	4 coppie guida, 4 griglie plastificate GN1/1
Control:	Electronic, display flush with the panel
Doors:	4 doors, self-closing, reversible with 105° stop
Door gasket:	Magnetic, triple chamber and easily replaceable
Insulation:	60 mm thickness - CFC/HCFC free
Exterior/interior finishing:	Exterior interior and back in AISI 304 stainless steel. Base in colaminated steel
Inner corners:	Rounded for easy cleaning and ensuring maximum hygiene
Lid hinges:	Made on black plastic
Handle:	Stainless steel AISI 304, 2 mm thick
Racks and slides:	Stainless steel AISI 304
Feets:	Stainless steel AISI 304, adjustable h 100-150 mm
Cosmo:	Ready for connection to Cosmo Hub

Accessories and variants

Drawers 1/2	GN1/2 container + lids kit for drawer, h 150 mm
Drawers 1/3	GN1/3 container + lids kit for drawer, h 150 mm
Drawers 1/3 + 2/3	Stainless steel shelf GN1/1
Special counter body heights 700 mm	Plastic coated shelf GN1/1
Special counter body heights 750 mm	Pair of type C slides 505 mm
Technical compartment on the left	Serial interface, RS485 cable
Special size of technical compartment	Cosmo connection kit
Lock with key for drawer 1/2	IP44 schuko socket with cover
Lock with key for drawer 1/3	Prep-Station pans kit GN1/6 plug-in, 4D
Lock with key for drawer 1/3 + 2/3	Removable plinth GN 4D h 50 mm
LED lighting	Removable plinth GN 4D h 100 mm
RAL customisable colouring	Removable plinth GN 4D h 150 mm
Plug-in water unit	
Power supply frequency 60Hz	
Other special voltage	
Adjustable feet h 145/195 mm	
6 Swivel and brake castors h 128 mm	
Brackets for GN pans for drawer	

COSMO - wi-fi control

Cosmo is the wi-fi technology that allow to connect and monitor all Coldline appliances. Connect Prep-Station counters to a Cosmo hub (MODI, VISION or LEVTRONIC) and from the app you can check the operating conditions of each machine and receive alerts in case of

*The installation requires a kit for the replacement of the racks

Technical draw

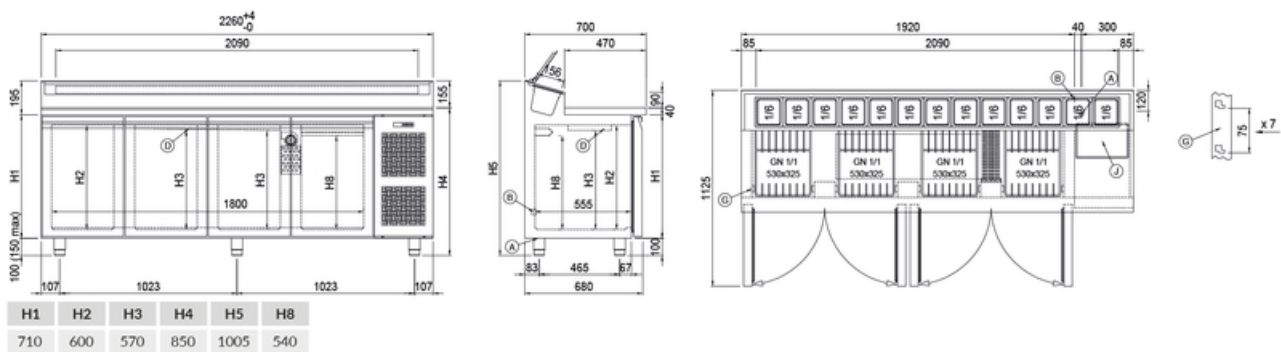

- A:** Power supply cable outlet **B:** Condensation water drain **D:** Airflow conveyor
- G:** Racks pitch **J:** Automatic evaporation of condensing water